

E2
SH4.0
 EAST WALL
 CROSS-SECTION AT PILE E2
 SCALE: 1" = 15'-0"

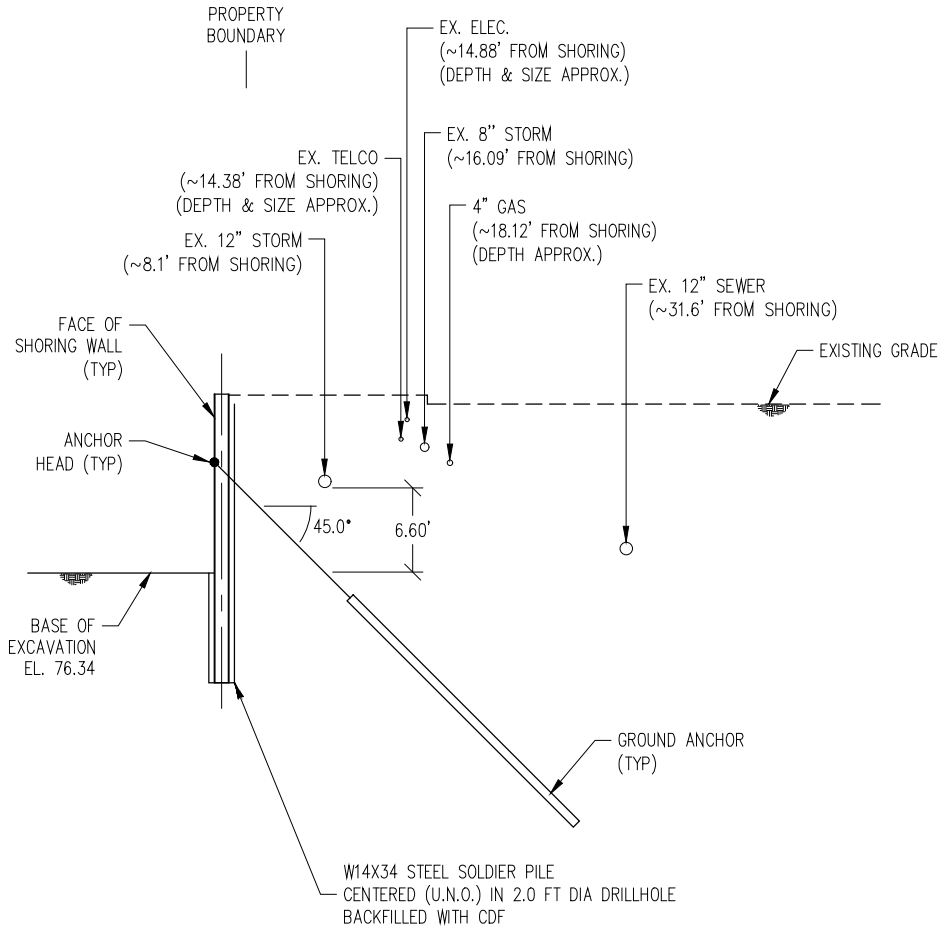

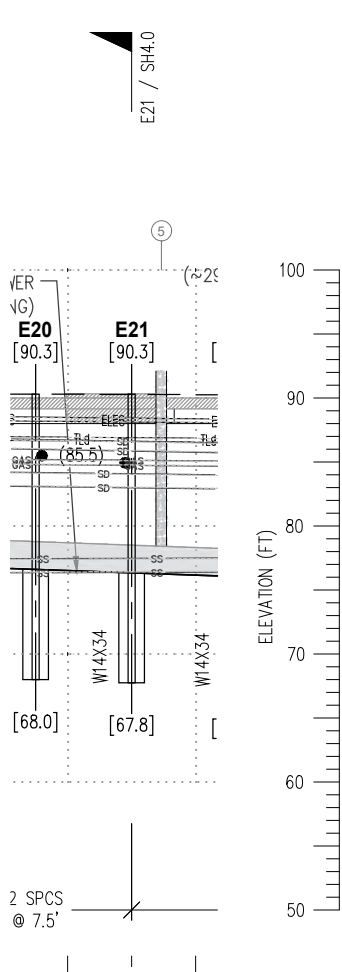

E21
SH4.0
EAST WALL
CROSS-SECTION AT PILE E21
SCALE: 1" = 15'-0"

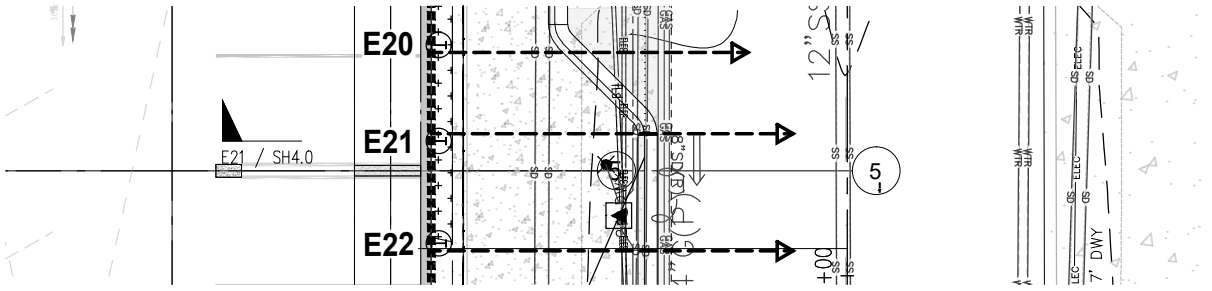

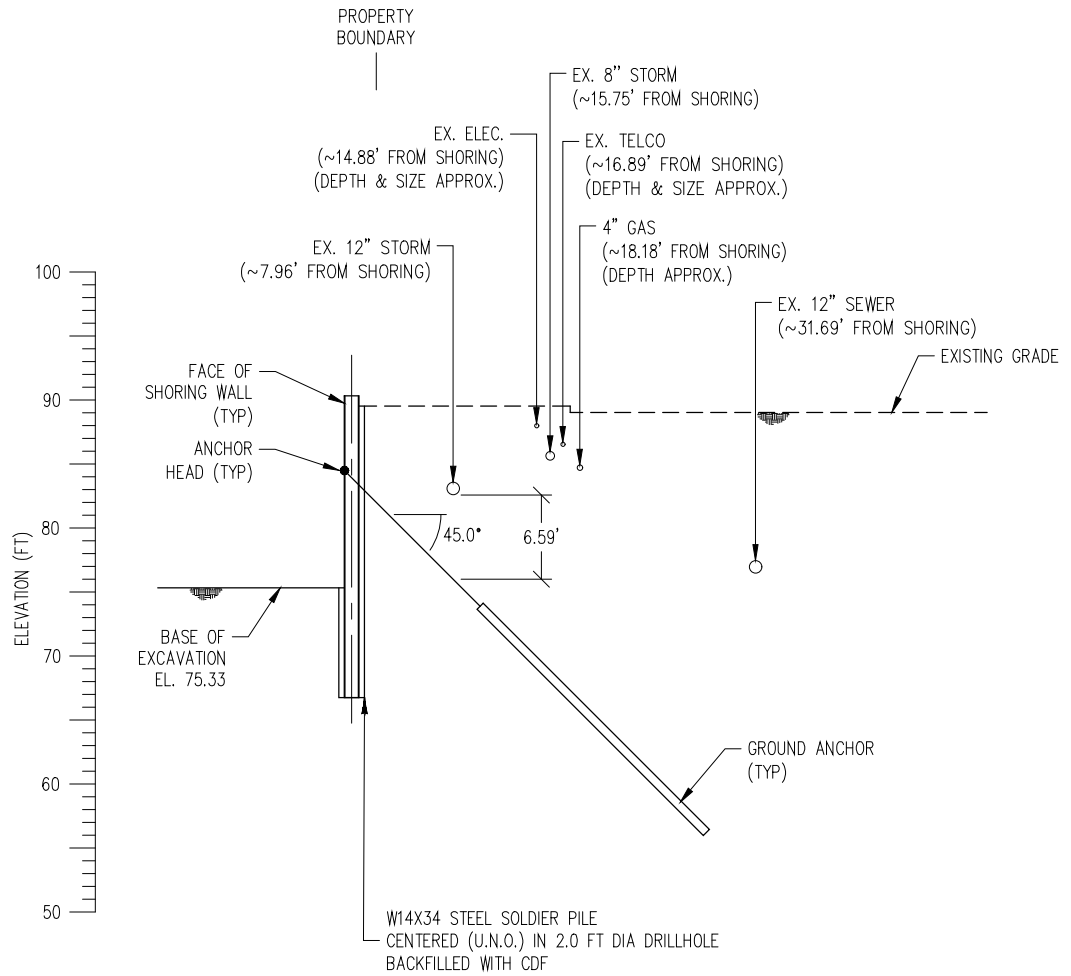
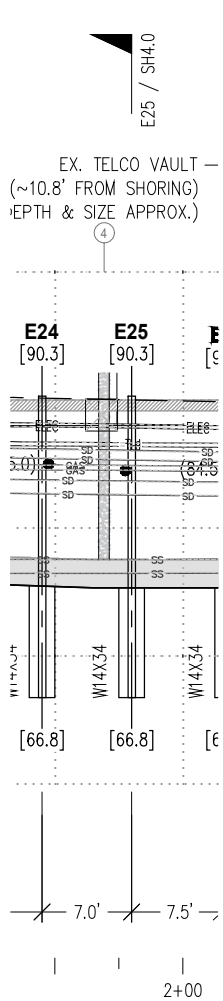
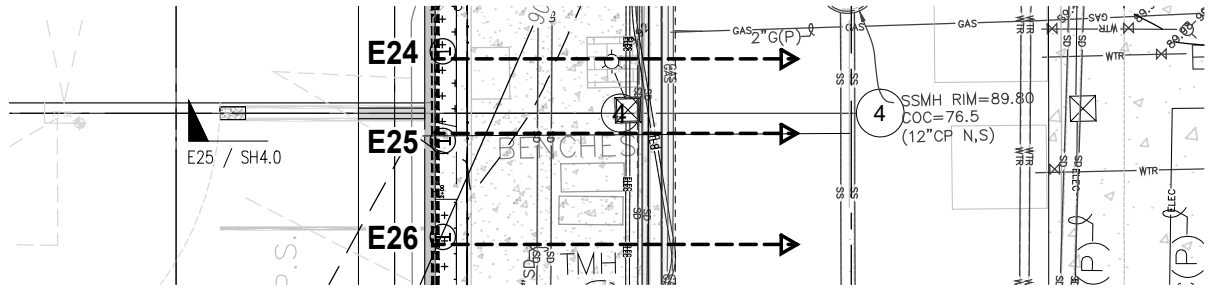

E25
SH4.0
EAST WALL
CROSS-SECTION AT PILE E25
 SCALE: 1" = 15'-0"



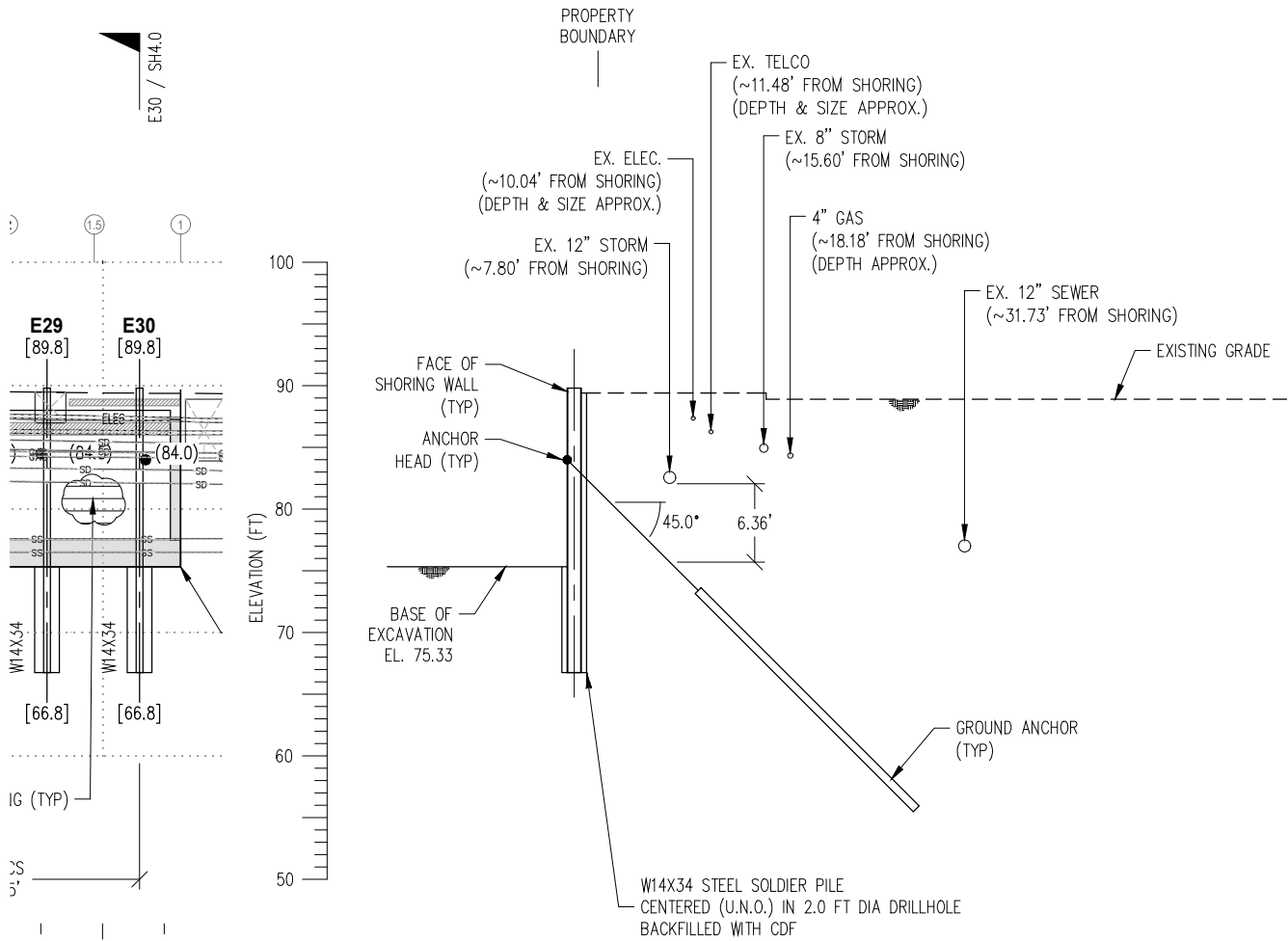
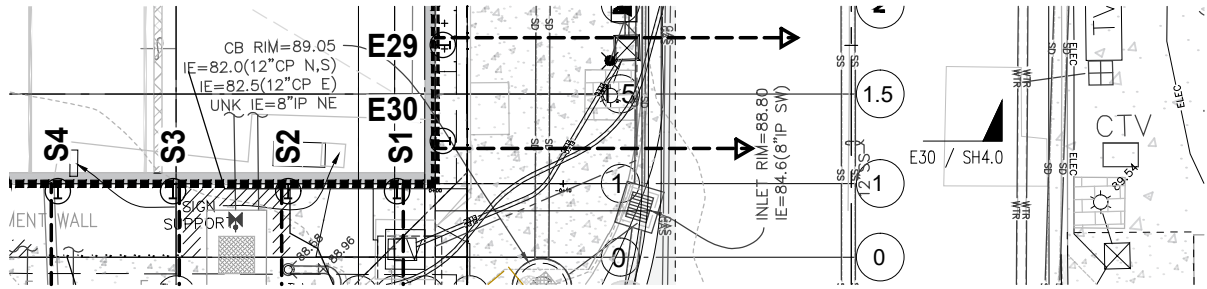

E30
SH4.0
 EAST WALL
 CROSS-SECTION AT PILE E30
 SCALE: 1" = 15'-0"



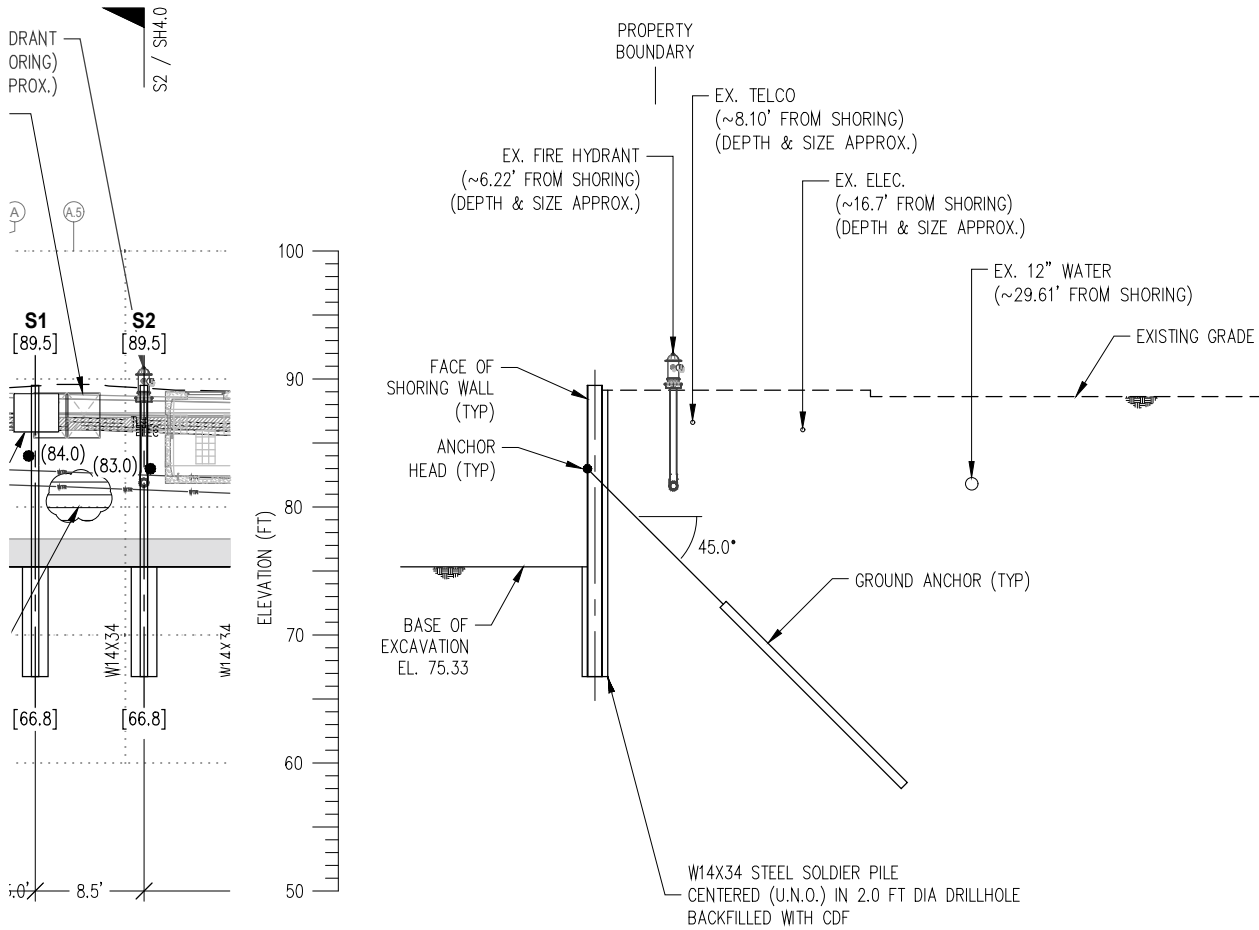
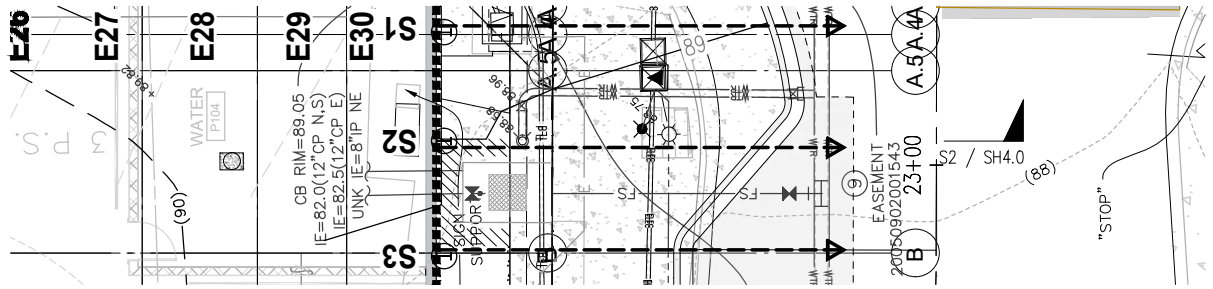

S2 SOUTH WALL
 CROSS-SECTION AT PILE S2
 SH4.0 SCALE: 1" = 15'-0"



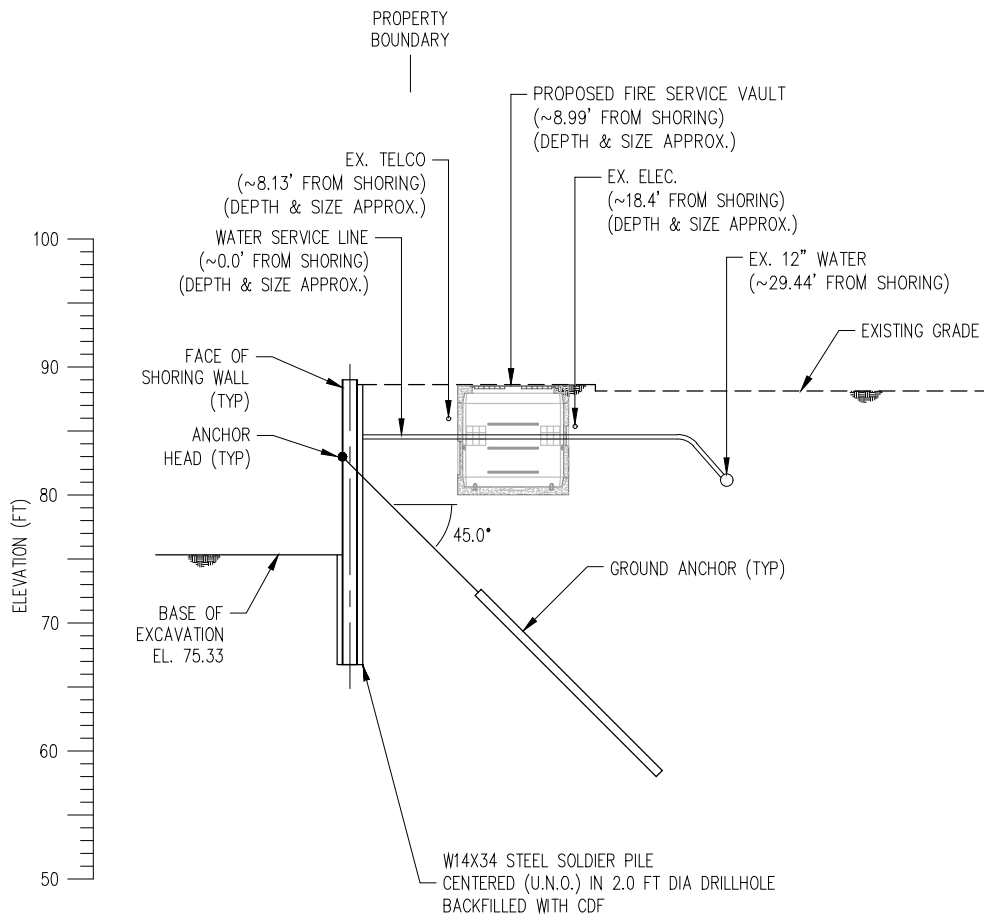
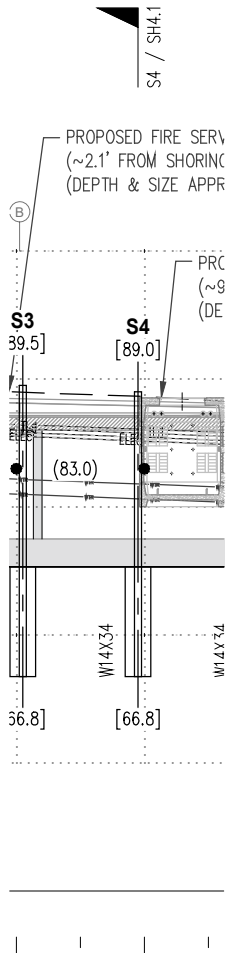
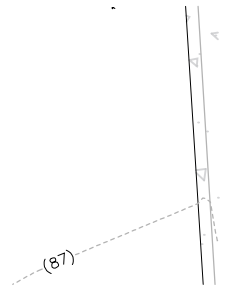
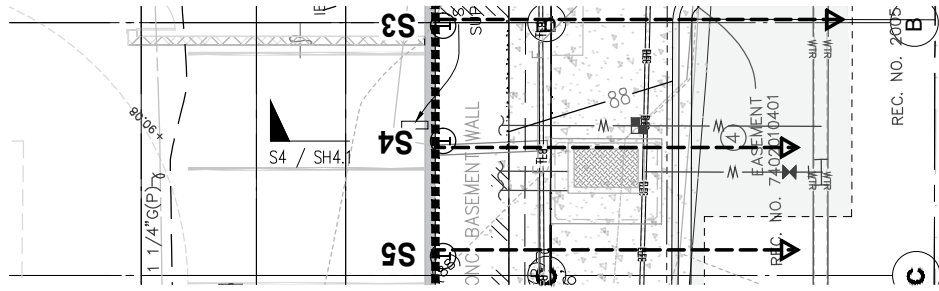

S4
SH4.1

 SOUTH WALL
 CROSS-SECTION AT PILE S4
 SCALE: 1" = 15'-0"



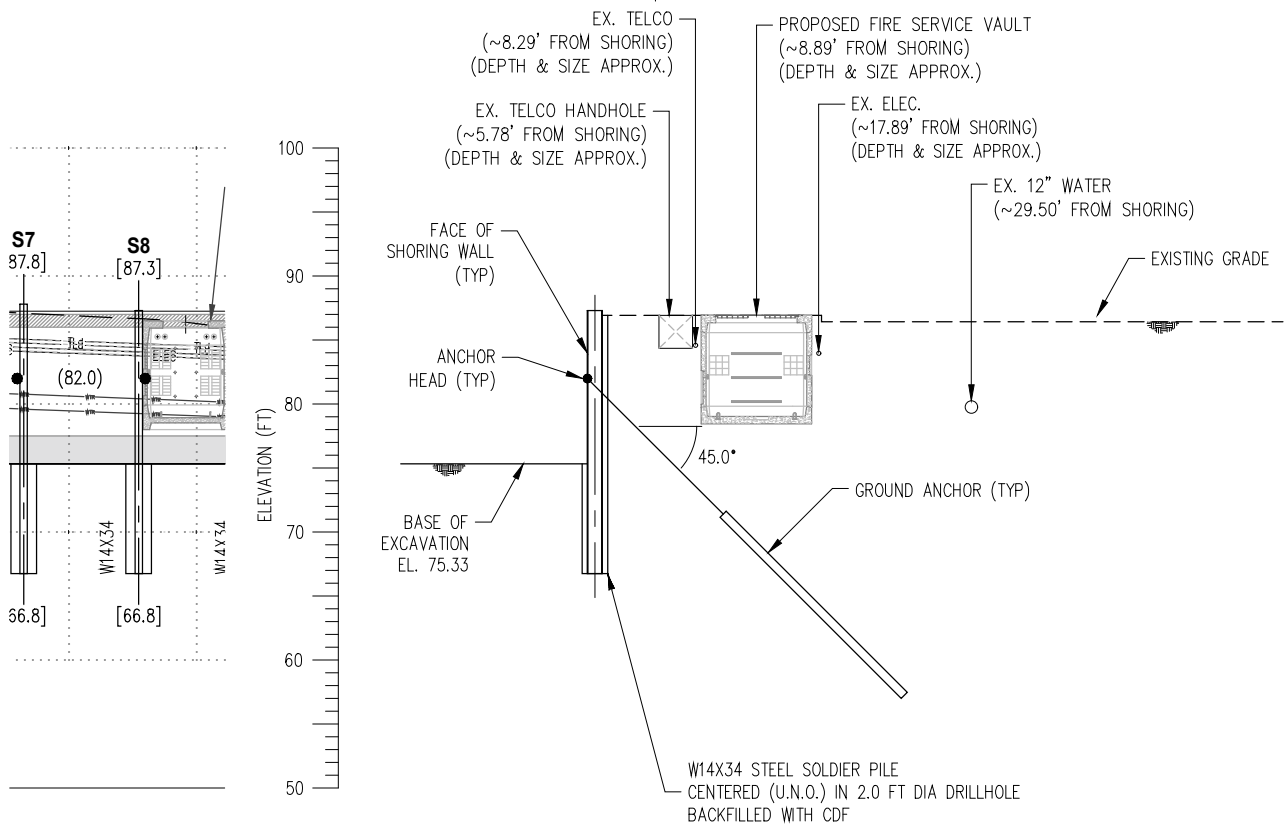
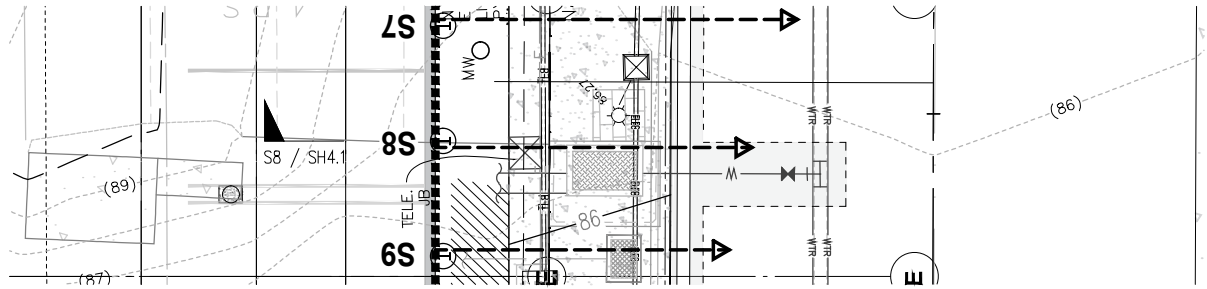

S8
 SH4.1

 SOUTH WALL
 CROSS-SECTION AT PILE S8
 SCALE: 1" = 15'-0"

